

Features::

- ◆ Equivalent to: TC2-112G2+
- ◆ 50Ω Impedance
- ◆ Frequency: 2 to 1100 MHz
- ◆ 260°C Reflow Compatible
- ◆ RoHS* compliant
- ◆ Operating temperature range: -40°C to +85°C
- ◆ Storage temperature range: -55°C to +100°C



Applications:

- ◆ For broadband and Cellular
- ◆ For VHF/UHF receivers/transmitters and push-pull amplifiers

Dimension Diagram (Unit:mm) :

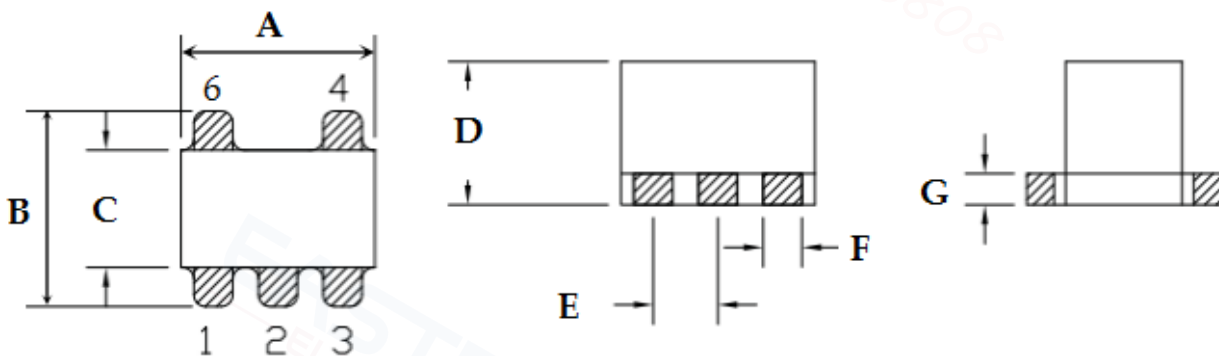

A=3.80±0.20 B=3.80±0.20 C=2.30±0.20 D=2.80±0.20 E=1.27±0.10 F=0.76±0.10 G=0.60±0.10

Electrical structure:

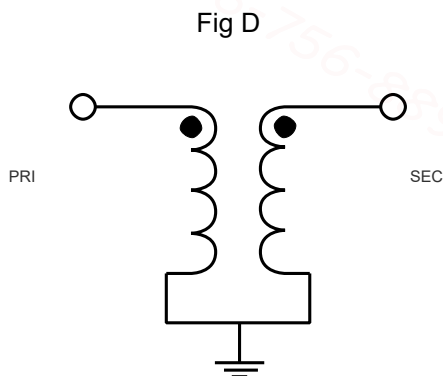

Recommended layout:

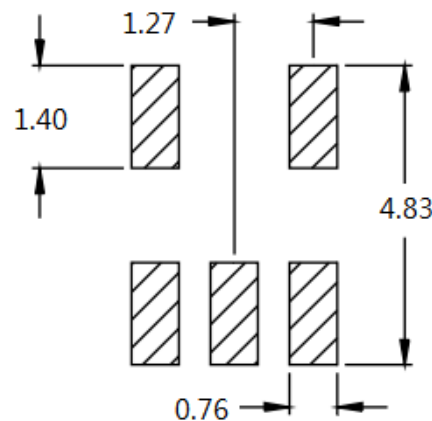

Pin Configuration:

Pin No.	Function
4	Primary Dot(e.g. 50 Ohm)
2,6	Not Connected
1	Ground
3	Secondary Dot(e.g. 25 Ohm)

Electrical Specifications: TA=25°C, 0dBm,Z0=50Ω:

Parameter	Test Conditions	Units	Min	Typ	Max
Main line Loss	2-1100MHz	dB	—	0.4	1.5
Input Return Loss	2-1100MHz	dB	10.0	25.0	—

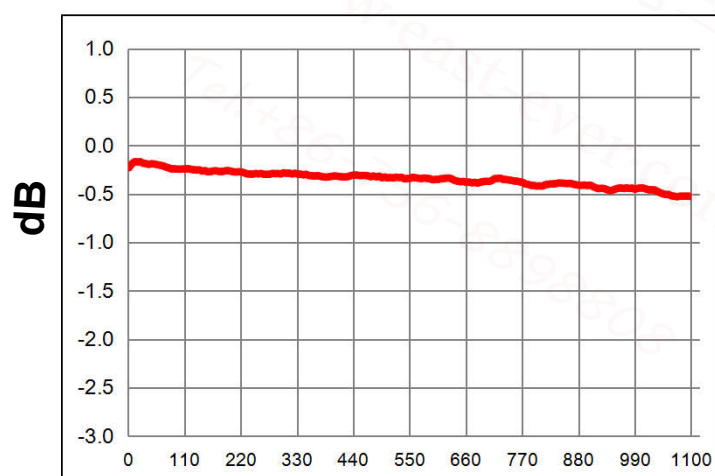
Main line Loss

Frequency(MHz)

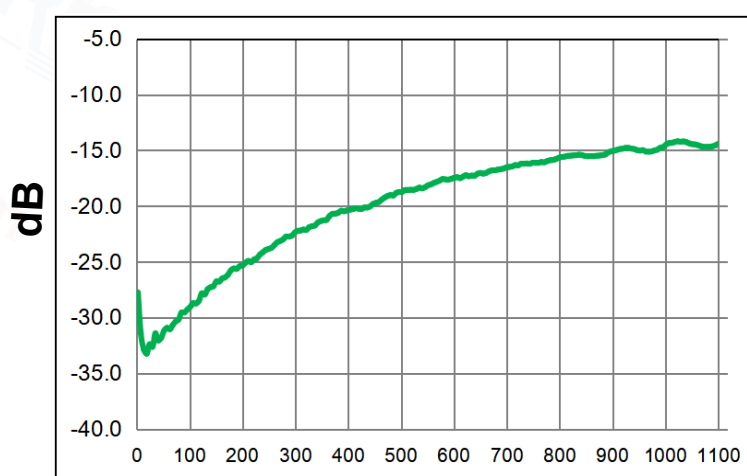
Input Return Loss

Frequency(MHz)

Recommended Soldering Temperature Graph:

Typical RoHS Reflow Profile

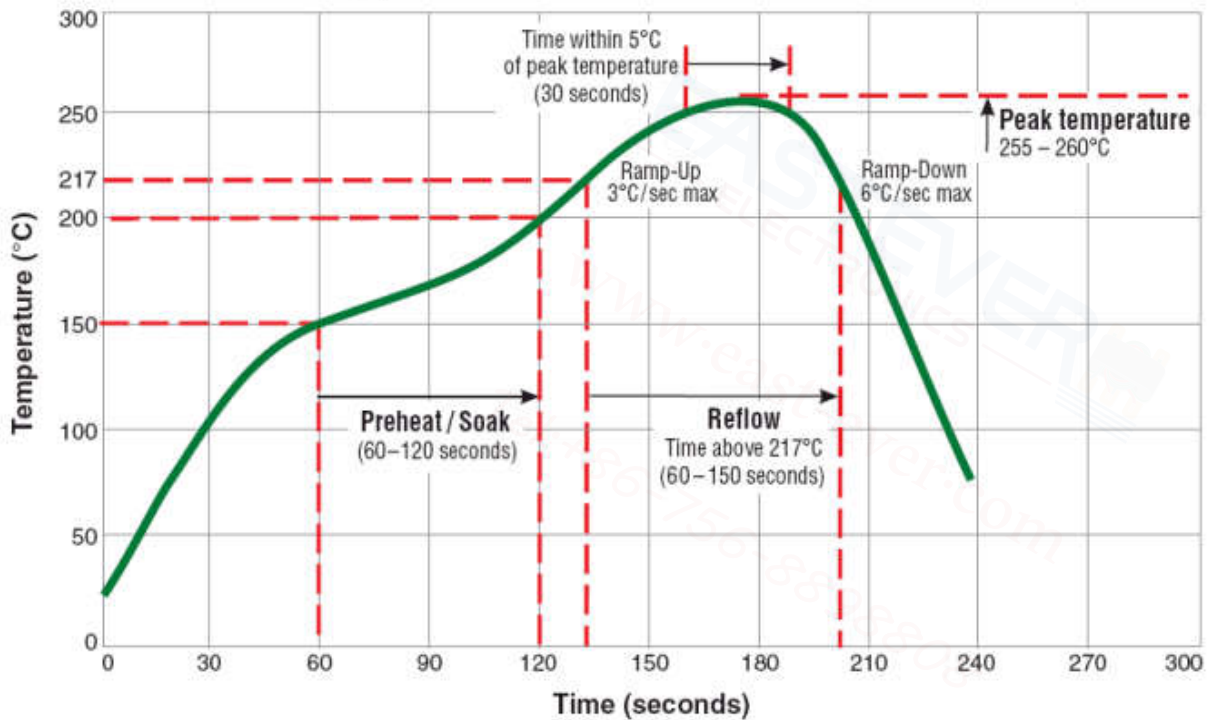

Packging Dimension For Caeier Tape(UNIT:mm):

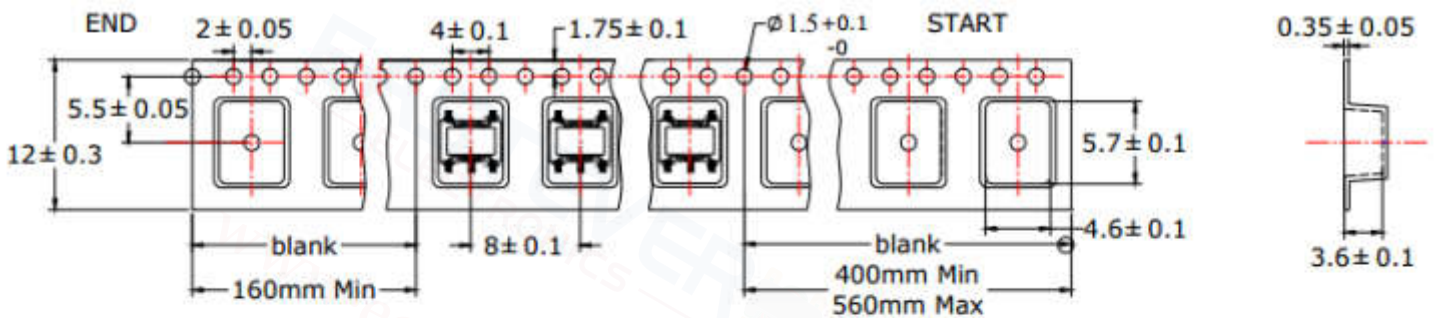

QUANTITY
2000pcs/reel
4Reel/Middle Carton
4Middle Carton/Big Carton
32000pcs/Big Carton

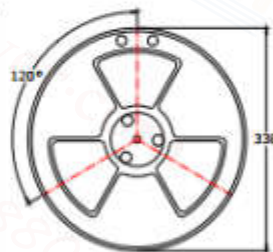

SPEC	8	12	16	24
DIM A±0.1	8.5	12.5	16.5	24.5
DIM B±0.1	2.3	2.3	2.3	2.3
DIM C±0.1	100	100	100	100

