

Features:



- ◆ Frequency Range: 5 to 2250 MHz
- ◆ Surface mount and available in tape and reel
- ◆ 260°C reflow compatible
- ◆ RoHS Compliant and Pb free
- ◆ Operating temperature range: -20°C to +85°C
- ◆ Storage temperature range: -55°C to +100°C

Applications:

- ◆ For catv
- ◆ For broadband and wireless communications

Dimension diagram (Unit:mm) :

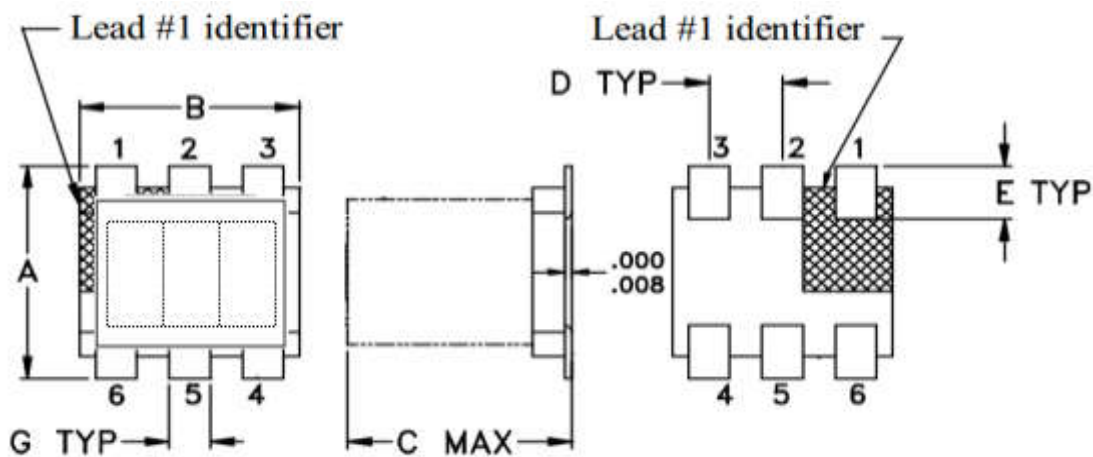

$A=4.20\pm 0.20$ $B=3.80\pm 0.20$ $C=2.80\pm 0.20$ $D=1.27\pm 0.05$ $E=1.00\pm 0.05$

Electrical structure:

Recommended layout(mm):

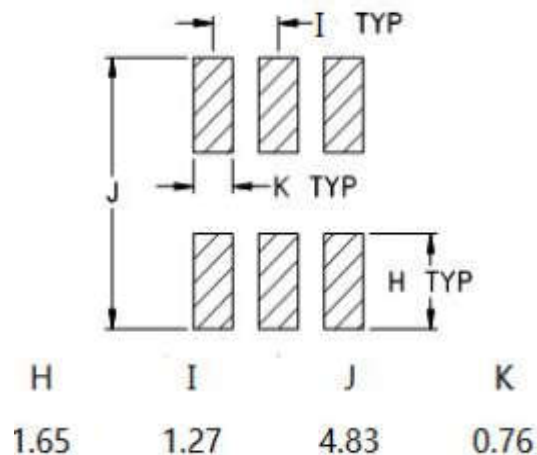
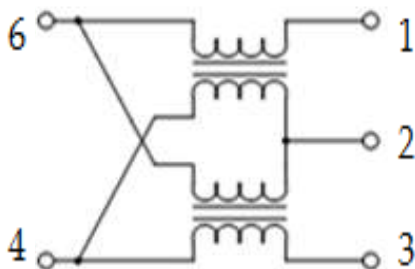

DRAW BY

yang lin

CHECKED BY

ye yong jun

APPROVED BY

deng gao

Pin configuration

Pin no.	Function
1	Coupled
2	Ground
3	Input
4	Output
6	Isolated

Application circuit :

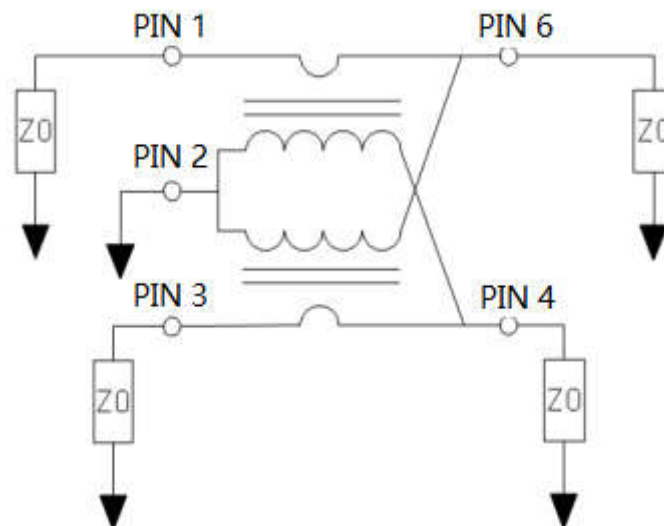

Electrical Specifications: $T_A = 25^\circ\text{C}$ $Z_0 = 75\Omega$

Parameter	Test Conditions	Units	Min	Typ	Max
Main line Loss	5-2250MHz	dB	—	1.0	2.0
Coupling	5-2250MHz	dB	—	16.5	19.0
Input Return Loss	5-2250MHz	dB	11.0	25.0	—
Output Return Loss	5-2250MHz	dB	12.0	28.0	—
Coupling Return Loss	5-2250MHz	dB	10.0	26.0	—
Isolation	5-2250MHz	dB	22.0	30.0	—

DRAW BY

yang lin

CHECKED BY

ye yong jun

APPROVED BY

deng gao

Main line Loss(pin3-4):

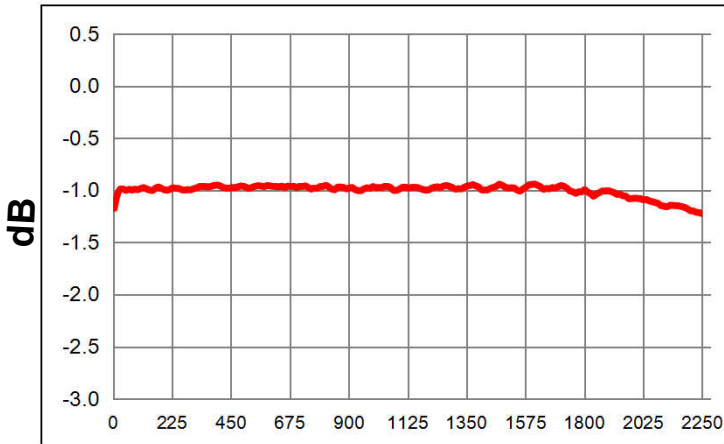

Frequency(MHz)

Coupling(pin3-1):

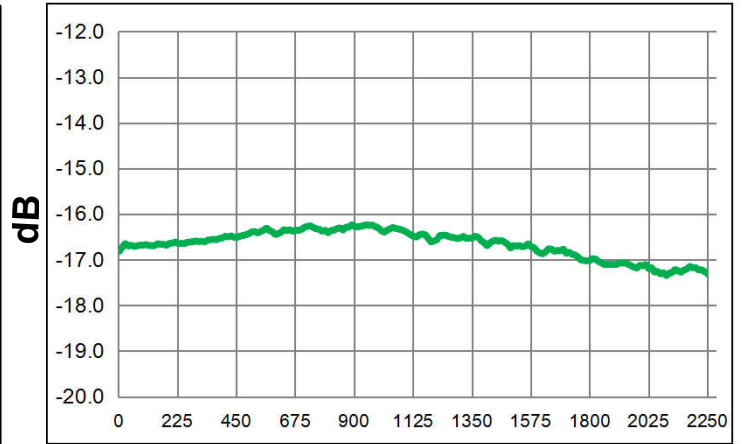

Frequency(MHz)

Input Return Loss (Pin3)

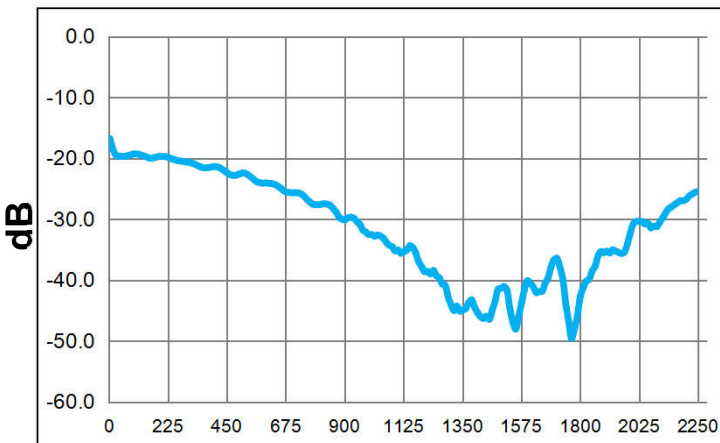

Frequency(MHz)

Output Return Loss (Pin4)

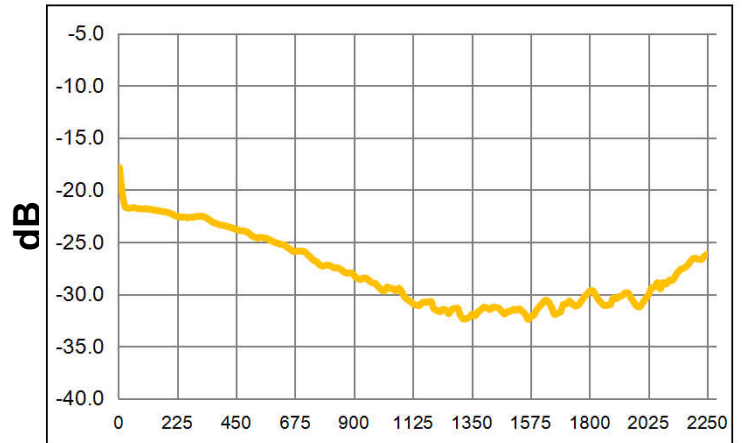

Frequency(MHz)

Coupling Return Loss (Pin1)

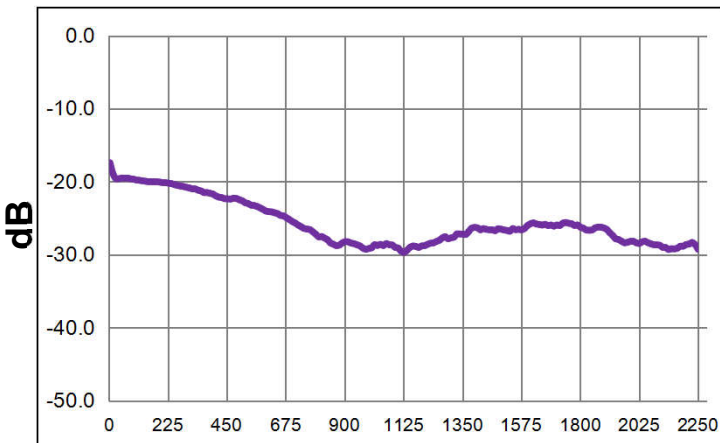

Frequency(MHz)

Isolation (Pin3-6)

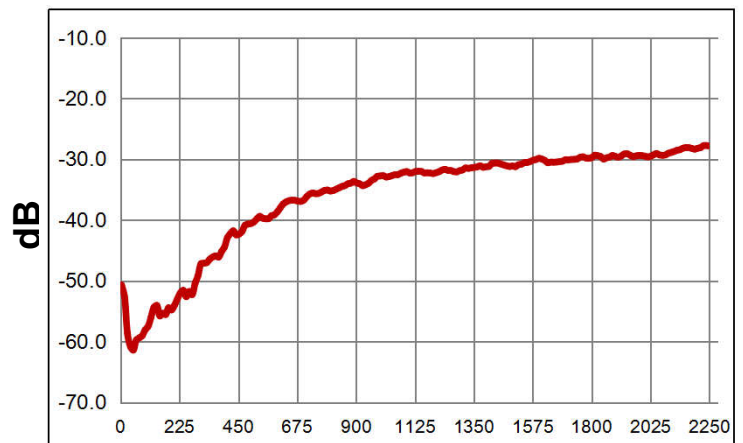

Frequency(MHz)

DRAW BY

yang lin

CHECKED BY

ye yong jun

APPROVED BY

deng gao

Recommended Soldering Temperature Graph:

Typical RoHS Reflow Profile

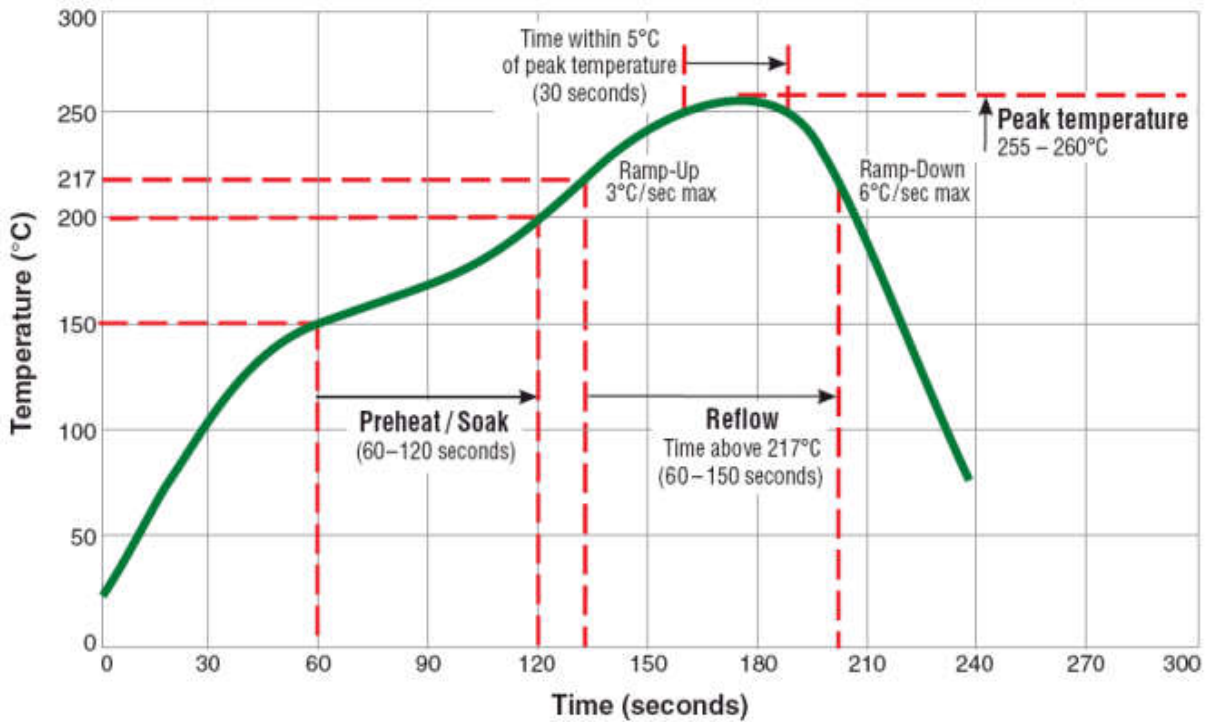

Packing Dimension For Caeier Tape(UNIT:mm):

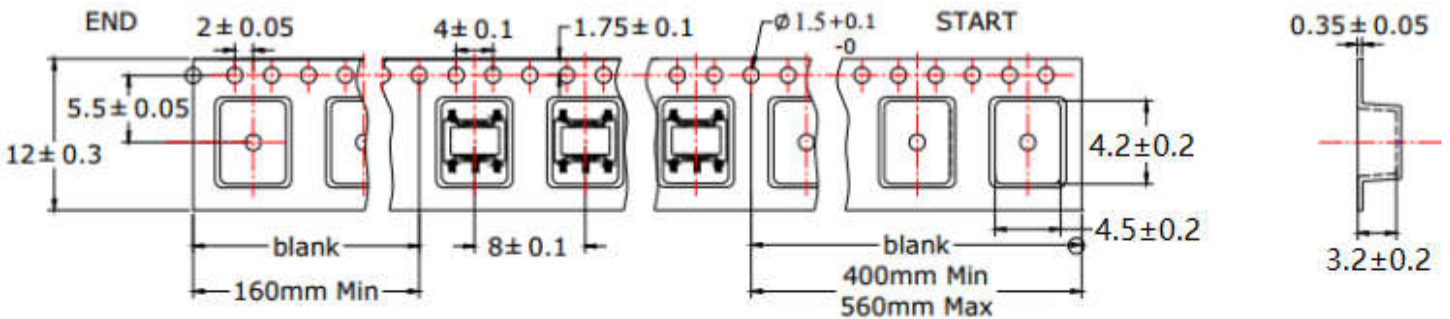

QUANTITY
2000PCS/Reel
4Reels/Middle Carton Middle Carton:
4 Middle Cartons/Big Carton
32000PCS/ Big Carton

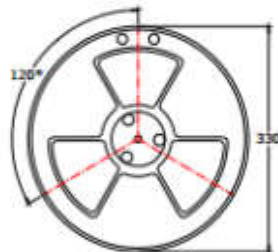

SPEC	8	12	16	24
DIM A±0.1	8.5	12.5	16.5	24.5
DIM B±0.1	2.3	2.3	2.3	2.3
DIM C±0.1	100	100	100	100

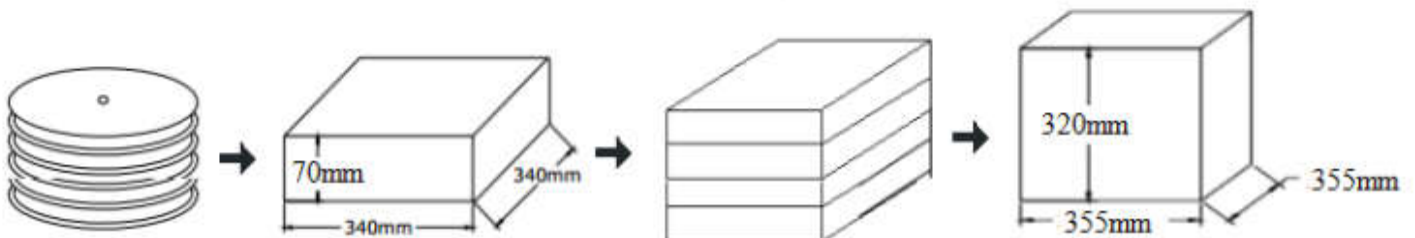

DRAW BY

yang lin

CHECKED BY

ye yong jun

APPROVED BY

deng gao