

**Features:**

- ◆ 50Ω Impedance
- ◆ Equivalent to: ADT1-6T
- ◆ Frequency: 0.3 to 125 MHz
- ◆ RF power: 0.50W
- ◆ DC current: 30mA
- ◆ Operating temperature range: -20°C to +85°C
- ◆ Storage temperature range: -55°C to +100°C

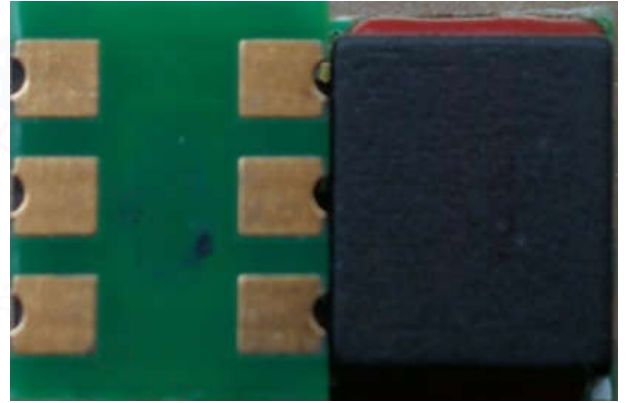

**Applications:**

- ◆ For impedance matching
- ◆ For balanced amplifier

**Dimension Diagram (Unit:mm) :**

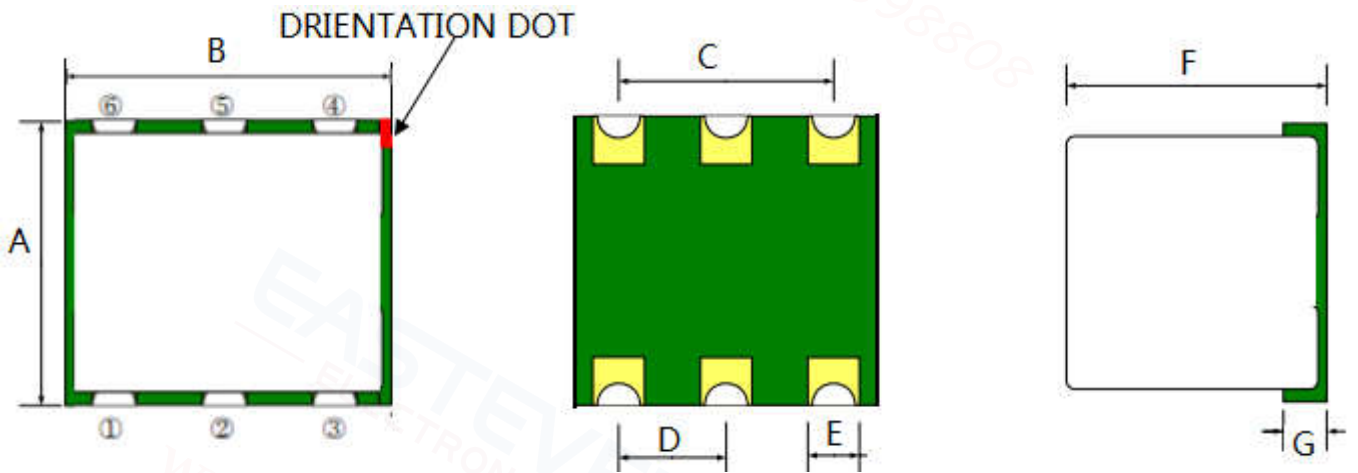

A:7.2±0.2 B:9.0±0.2 C:5.1±0.1 D:2.6±0.1 E:1.6±0.1 F:5.5±0.2 G:0.6±0.1

**Electrical structure:**

**Recommended layout:**

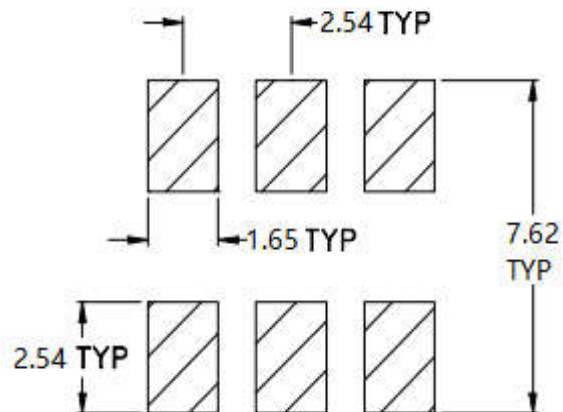
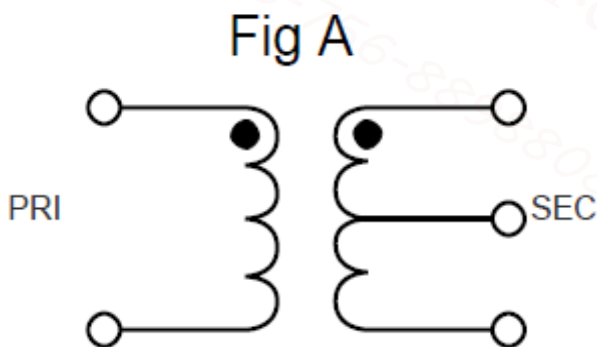

**Pin configuration:**

Pin No.	Function
1	Output2
2	Ground
3	Output1
4	Input
6	Ground

**Application circuit :**

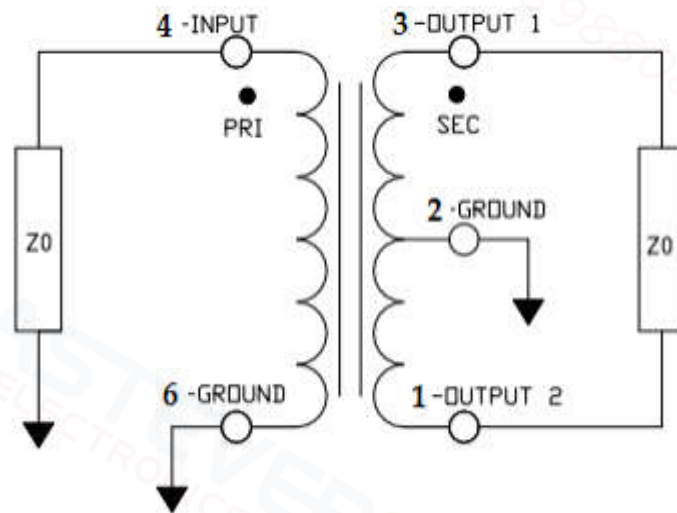

**Electrical Specifications: TA=25°C , 0dBm,Z0=50Ω:**

Parameter	Test Conditions	Units	Min	Typ	Max
Main line Loss(out1)	0.3-125MHz	dB	—	0.6	2.5
Main line Loss(out2)	0.3-125MHz	dB	—	0.3	2.0
Amplitude Balance	0.3-125MHz	dB	—	0.2	±0.5
Phase Balance	0.3-125MHz	Degrees	—	5.0	±10.0
Input Return Loss	0.3-125MHz	dB	6.0	25.0	—

### Main line Loss(out1)

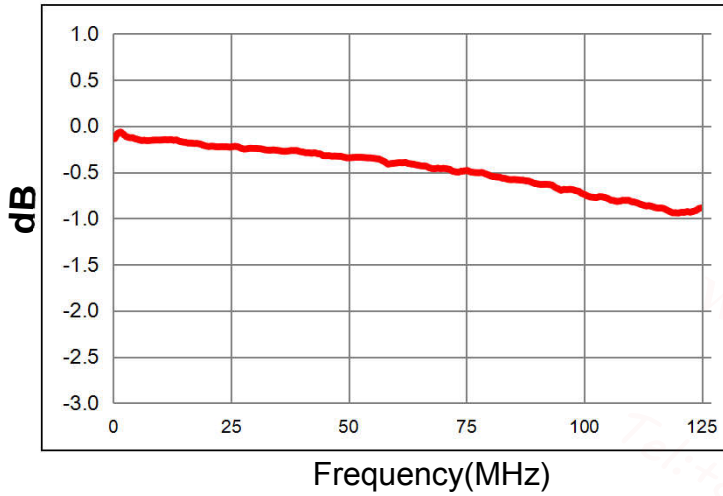

### Main line Loss(out2)

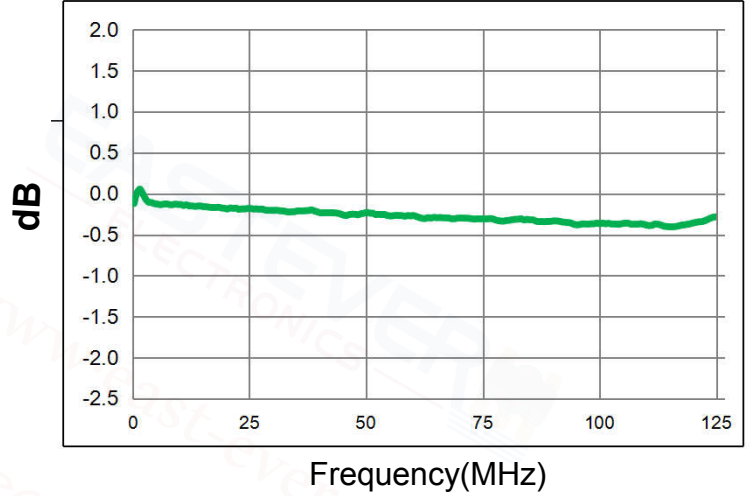

### Amplitude Balance

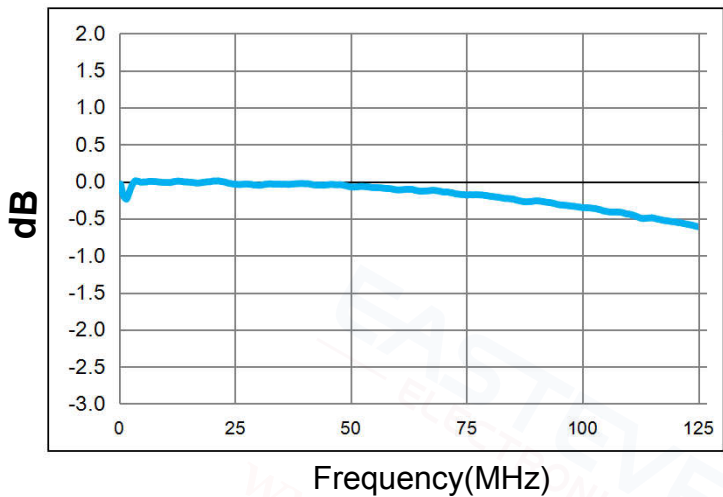

### Phase Balance

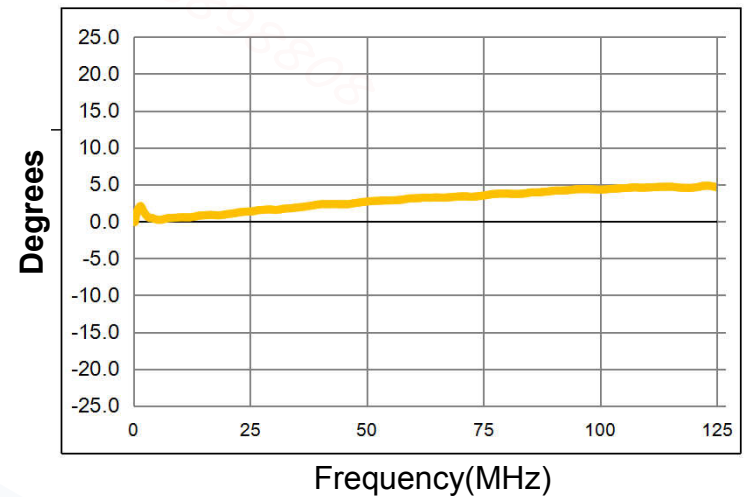

### Input Return Loss

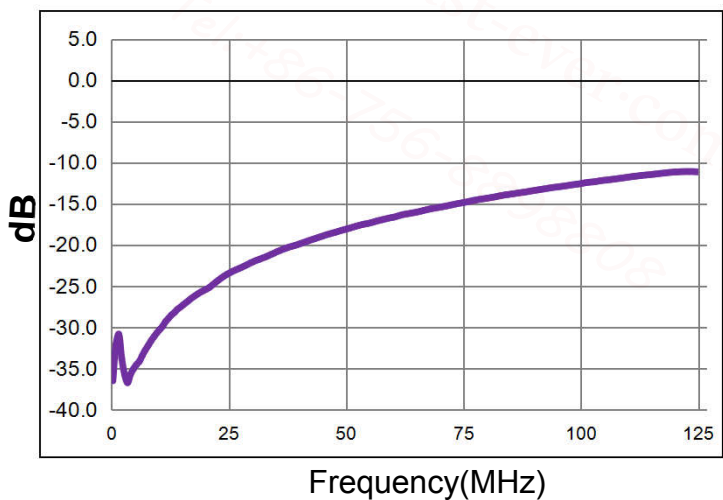

Recommended Soldering Temperature Graph:

Typical RoHS Reflow Profile

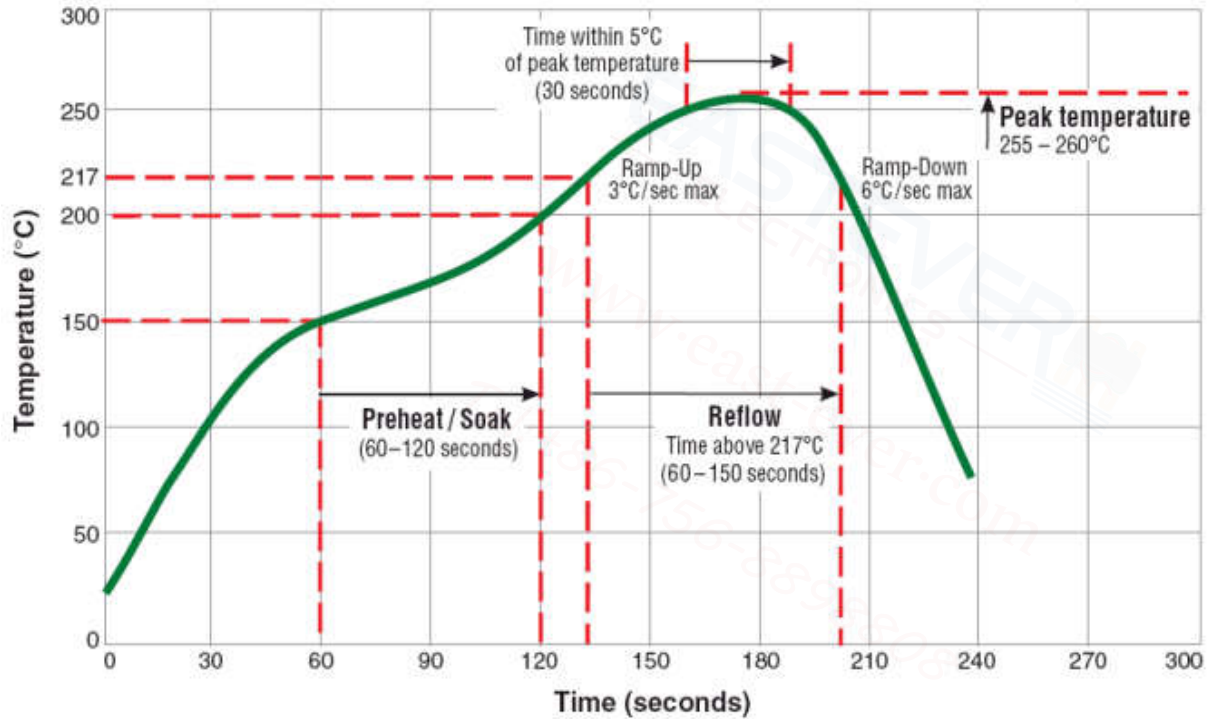

Packging Dimension For Carrier Tape(UNIT:mm):

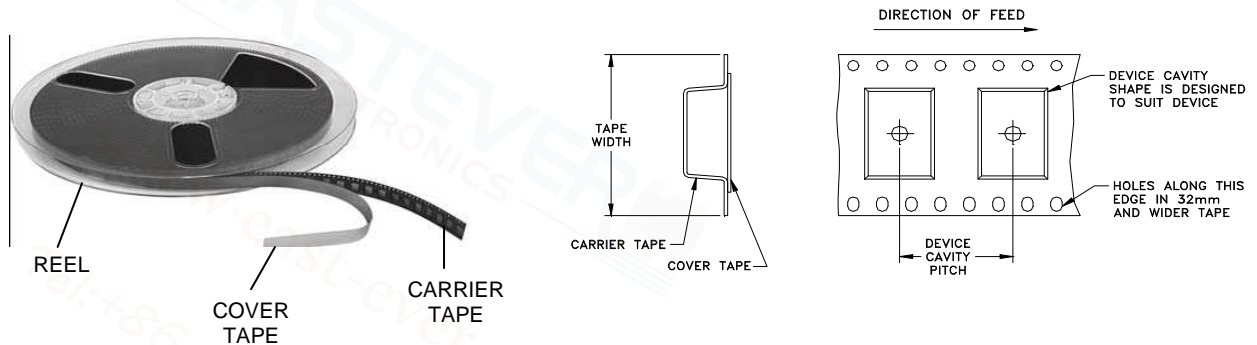

Carrier Tape Orientation

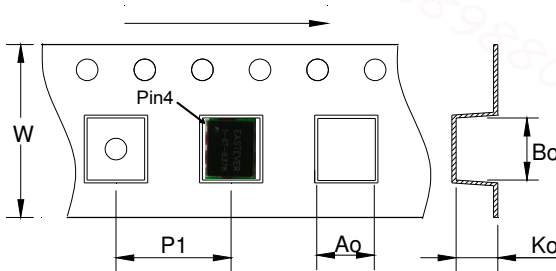

Tape & Reel Information

Parameter	Units	Value
Qty per reel	PCS	700
Reel Size	mm	330
Tape Width	mm	16.00
Pitch	mm	12.00
Ao	mm	7.50
Bo	mm	9.50
Ko	mm	6.00

Reel Size

